





Segundo pesquisas
um produto bem exposto
é responsável por
70% das compras
não planejadas

ÍNDICE

FIT

04



LINE

09

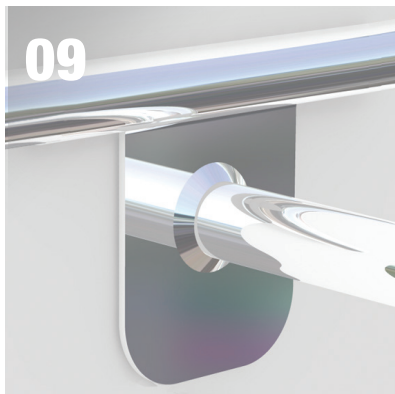

MAG 16

14

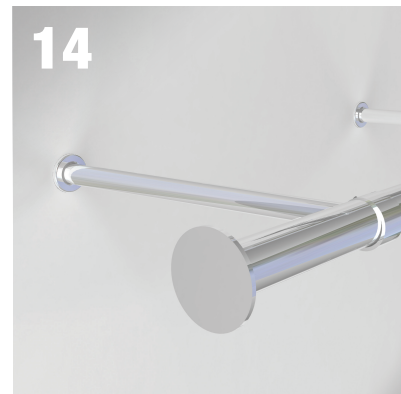

DOT

19

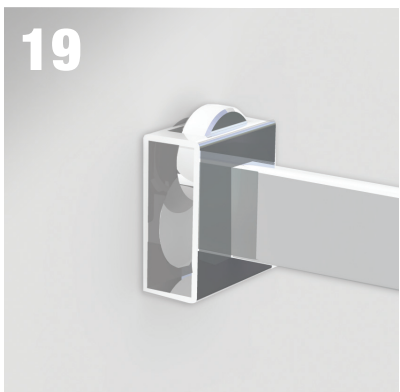

SLIM

22



WAVE

32



SIDE

39



MIDDLE

46





MONTANTE

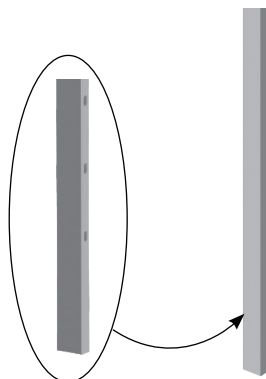

código	dimensões	preço
SIDE01__200*	1,5x3,5x191cm	
SIDE01__250*	1,5x3,5x247,5cm	
SIDE01__300*	1,5x3,5x295cm	

SUPORTE DISTANCIADOR DE PAREDE

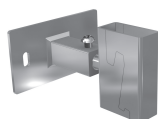

código	dimensões	preço
SIDE02__*	mín5/ max8x6x9cm	

2 unidades para montantes de 200 e 250cm e 3 unidades para montantes de 300cm

PÉ NIVELADOR



código	dimensões	preço
SIDE03__*	5x5x8cm	

ACABAMENTOS

CR (cromado)

*Pintura:
BF (branco fosco)
BT (branco total)
PT (prata)

PR (preto semi fosco)
PX (preto micro texturizado)

PREÇOS COM IPI

MÃO FRANCESA



código	dimensões	preço
--------	-----------	-------

SIDE04_ _35*	2x6x35cm	
--------------	----------	--

tubo 15x35

SUPORTE VIDRO 8MM



código	dimensões	preço
--------	-----------	-------

SIDE05_ _*	2x6x10cm	
------------	----------	--

RT RETO



código	dimensões	preço
--------	-----------	-------

SIDE06_ _35*	2x6x35cm	
--------------	----------	--

tubo 15x35

ARARA T



código	dimensões	preço
--------	-----------	-------

SIDE07_ _60*	6x35x58cm	
--------------	-----------	--

tubo 15x35

ACABAMENTOS

CR (cromado)

*Pintura:

BF (branco fosco)

BT (branco total)

PT (prata)

PR (preto semi fosco)

PX (preto micro texturizado)

PREÇOS COM IPI

SUPORE INVISÍVEL

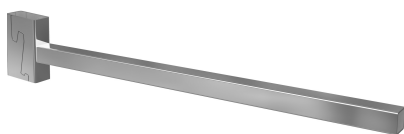

código	dimensões	preço
SIDE08__35*	2x6x35cm	
tubo 16x16		

SUPORE ARARA 15X35



código	dimensões	preço
SIDE09__30*	3,5x6x30cm	
tubo 15x35		

SUPORE 5CM BARRA 15X35

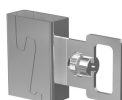

código	dimensões	preço
SIDE10__05*	2x6x9cm	

BARRA15X35



código	dimensões	preço
SIDE11__80*	1,5x3,5x79cm	
SIDE11__100*	1,5x3,5x98cm	
SIDE11__120*	1,5x3,5x118cm	
tubo 15x35		

ACABAMENTOS

CR (cromado)

*Pintura:

BF (branco fosco)

BT (branco total)

PT (prata)

PR (preto semi fosco)

PX (preto micro texturizado)

PREÇOS COM IPI

MÃO FRANCESA 35CM BARRA15X35

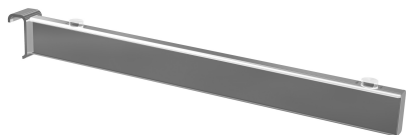

código	dimensões	preço
SIDE12__35*	4x5x35cm	

RT RETO BARRA 15X35



código	dimensões	preço
SIDE70__	4x5x30cm	
tubo 15x35		

ACABAMENTOS

CR (cromado)

*Pintura:

BF (branco fosco)

BT (branco total)

PT (prata)

PR (preto semi fosco)

PX (preto micro texturizado)

PREÇOS COM IPI



BARRA HR

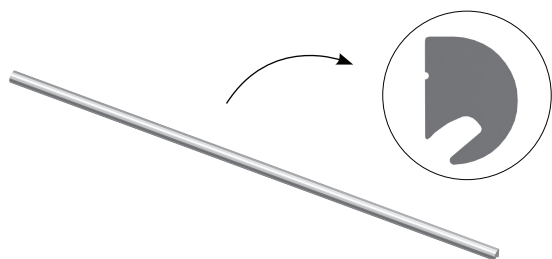

código	dimensões	preço
HZ01AL62	1x1,3x62,5cm	
HZ01AL125	1x1,3x125cm	
alumínio		

BARRA HQ

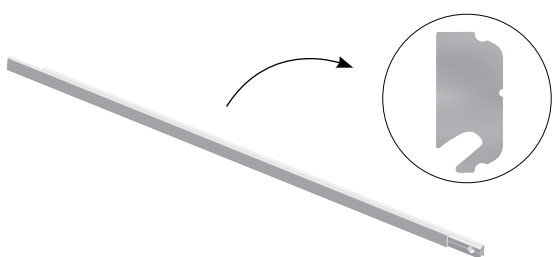

código	dimensões	preço
HZ02AL62	1x1,8x62,5cm	
HZ02AL125	1x1,8x125cm	
alumínio		

TAMPA ACABAMENTO HQ

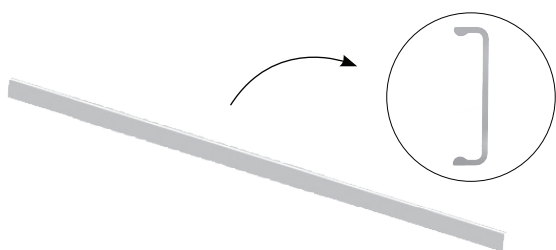

código	dimensões	preço
HZ03AL62	1x1,8x62,5cm	
HZ03AL125	1x1,8x125cm	
alumínio		

RT RETO 13



código	dimensões	preço
HZ04__30*	3,5x6x30cm	
HZ04CR30	3,5x6x30cm	
tubo ø 1/2 pol		

RT INCLINADO 13

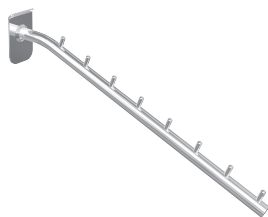

código	dimensões	preço
HZ05__30*	3,5x6x30cm	
HZ05CR30	3,5x6x30cm	
tubo ø 1/2 pol		

ACABAMENTOS

CR (cromado)

*Pintura:
BF (branco fosco)
BT (branco total)
PT (prata)

PR (preto semi fosco)
PX (preto micro texturizado)

PREÇOS COM IPI

MÃO FRANCESA 13



código	dimensões	preço
HZ06__30*	3,5x6x30cm	
HZ06CR30	3,5x6x30cm	
HZ06__35*	3,5x6x35cm	
HZ06CR35	3,5x6x35cm	

tubo Ø 1/2 pol

SUPORE TRAVESSA 13



código	dimensões	preço
HZ07__30*	3,5x6x30cm	
HZ07CR30	3,5x6x30cm	

tubo Ø 1/2 pol

TRAVESSA 13

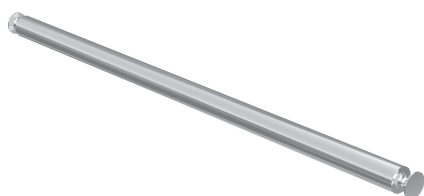

código	dimensões	preço
HZ08__80*	1,9x1,9x80cm	
HZ08CR80	1,9x1,9x80cm	
HZ08__100*	1,9x1,9x100cm	
HZ08CR100	1,9x1,9x100cm	
HZ08__120*	1,9x1,9x120cm	
HZ08CR120	1,9x1,9x120cm	

tubo Ø3 / 4 pol

RT RETO 19

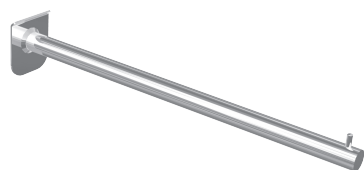

código	dimensões	preço
HZ09__35*	5x6x35cm	
HZ09CR35	5x6x35cm	

tubo Ø3 / 4 pol

ACABAMENTOS

CR (cromado)

*Pintura:
BF (branco fosco)
BT (branco total)
PT (prata)

PR (preto semi fosco)
PX (preto micro texturizado)

PREÇOS COM IPI

RT INCLINADO 19

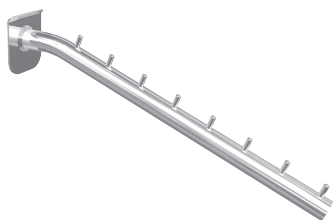

código	dimensões	preço
HZ10__35*	5x6x35cm	
HZ10CR35	5x6x35cm	
tubo Ø3 / 4 pol		

MÃO FRANCESA 19



código	dimensões	preço
HZ11__30*	5x6x30cm	
HZ11CR30	5x6x30cm	
HZ11__35*	5x6x35cm	
HZ11CR35	5x6x35cm	
tubo Ø3 / 4 pol		

MÃO FRANCESA ASCENDENTE 19



código	dimensões	preço
HZ20__30*	5x6x30cm	
HZ20CR30	5x6x30cm	
HZ20__35*	5x6x35cm	
HZ20CR35	5x6x35cm	
tubo Ø3 / 4 pol		

SUPORTE TRAVESSA 19



código	dimensões	preço
HZ12__30*	5x6x30cm	
HZ12CR30	5x6x30cm	
tubo Ø3 / 4 pol		

ACABAMENTOS

CR (cromado)

*Pintura:

BF (branco fosco)

BT (branco total)

PT (prata)

PR (preto semi fosco)

PX (preto micro texturizado)

PREÇOS COM IPI

TRAVESSA 19



código	dimensões	preço
HZ13__80*	2,5x2,5x80cm	
HZ13CR80	2,5x2,5x80cm	
HZ13__100*	2,5x2,5x100cm	
HZ13CR100	2,5x2,5x100cm	
HZ13__120*	2,5x2,5x120cm	
HZ13CR120	2,5x2,5x120cm	

tubo Ø 1 pol

GANCHO



código	dimensões	preço
HZ14__15*	3,5x6x15cm	
HZ14CR15	3,5x6x15cm	
HZ14__20*	3,5x6x20cm	
HZ14CR20	3,5x6x20cm	
HZ14__25*	3,5x6x25cm	
HZ14CR25	3,5x6x25cm	

arame Ø 6mm

PORTA CALÇADO



código	dimensões	preço
HZ18__*	4x10x15cm	
HZ18CR	4x10x15cm	

arame Ø 6mm

ACABAMENTOS

CR (cromado)

*Pintura:
 BF (branco fosco)
 BT (branco total)
 PT (prata)

PR (preto semi fosco)
 PX (preto micro texturizado)

PREÇOS COM IPI



BUCHA MAG 16



código	dimensões	preço
--------	-----------	-------

4500CR	3x3x3,4cm	
--------	-----------	--

CHAPA DE APOIO E FIXAÇÃO

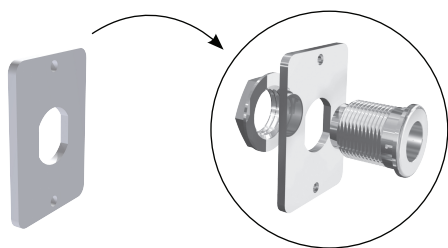

código	dimensões	preço
--------	-----------	-------

4501ZN	0,4x5x7cm	
--------	-----------	--

somente zincado

SUPORE ARARA PRAT. MAG 16



código	dimensões	preço
--------	-----------	-------

4575CR	2x8,2x30cm	
--------	------------	--

tubo \varnothing 5/8 pol

SUPORE ARARA SIMPLES MAG 16



código	dimensões	preço
--------	-----------	-------

4576CR	2x6,2x33cm	
--------	------------	--

tubo \varnothing 5/8 pol

TRAVESSA TB. RED. 1POL. MAG 16



código	dimensões	preço
--------	-----------	-------

4577CR	2,5x2,5x65cm	
--------	--------------	--

4578CR	2,5x2,5x85cm	
--------	--------------	--

4579CR	2,5x2,5x105cm	
--------	---------------	--

4586CR	2,5x2,5x125cm	
--------	---------------	--

ACABAMENTOS

CR (cromado)

PREÇOS COM IPI

ACAB. TRAV. TB. RED. 1POL. MAG 16



código	dimensões	preço
4600CR	3x3,8x3,8cm	

ACAB. TRAV. RED. PVC MAG 16



código	dimensões	preço
4602CR	0,8x2,5x2,5cm	

SUPORE TRAV. TB. OBL. MAG 16



código	dimensões	preço
4580CR	1,6x4x5cm	

TRAVESSA TB. OBLONGO

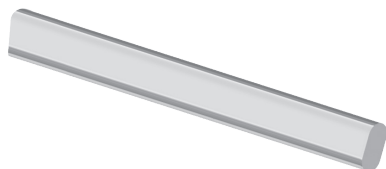

código	dimensões	preço
2075CR	1,6x3x65cm	
2080CR	1,6x3x85cm	
2085CR	1,6x3x105cm	
2090CR	1,6x3x125cm	

RT RETO MAG 16



código	dimensões	preço
4545CR	1,6x1,6x33cm	
tubo ø 5/8 pol		

ACABAMENTOS

CR (cromado)

PREÇOS COM IPI

RT INCLINADO MAG 16

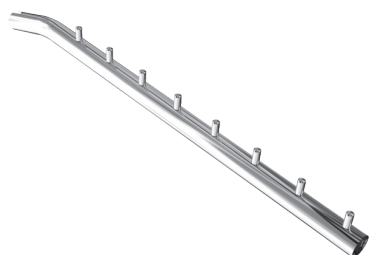

código	dimensões	preço
--------	-----------	-------

4535CR	1,6x1,6x33cm	
--------	--------------	--

tubo ø 5/8 pol

SUPORTE PRAT. MADEIRA MAG 16



código	dimensões	preço
--------	-----------	-------

4573CR	1,6x6,2x33cm	
--------	--------------	--

tubo ø 5/8 pol

SUPORTE PRAT. VIDRO MAG 16



código	dimensões	preço
--------	-----------	-------

4572CR	1,6x6,2x33cm	
--------	--------------	--

tubo ø 5/8 pol

PEG BOARD SEM ESFERA MAG 16



código	dimensões	preço
--------	-----------	-------

4519CR	1,6x1,6x10cm	
--------	--------------	--

4520CR	1,6x1,6x15cm	
--------	--------------	--

4521CR	1,6x1,6x20cm	
--------	--------------	--

arame ø 6mm

ACABAMENTOS

CR (cromado)

PREÇOS COM IPI

CHAVE DE ALINHAMENTO DA BUCHA MAG 16



código	dimensões	preço
4599	1,6x8x8,5cm	
zincado		

PORTA BOLA MAG 16



código	dimensões	preço
4591CR	1,6x15,5x25,5cm	
arame \varnothing 6mm		

PORTA BONÉ MAG 16

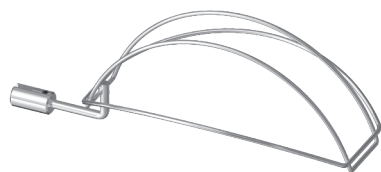

código	dimensões	preço
4593CR	15x20x23cm	
arame \varnothing 0,3 pol		

ACABAMENTOS

CR (cromado)

PREÇOS COM IPI





PONTO PREMIUM

código	dimensões	preço
PP01AL	1x3x3cm	
somente alumínio		

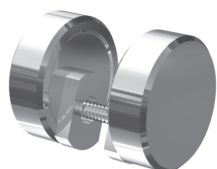

PONTO PREMIUM DUPLO

código	dimensões	preço
PP17AL	3,5x3x3cm	
somente alumínio		

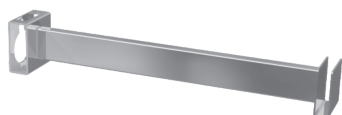

SUPORTE BARRA 10X30

código	dimensões	preço
PP02CR30	4,4x5x30cm	
tubo 10x30		

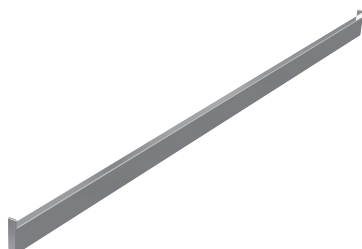

BARRA 10X30

código	dimensões	preço
PP03CR60	1x3x60cm	
PP03CR80	1x3x80cm	
PP03CR100	1x3x100cm	
tubo 10x30		



SUPORTE BARRA 5 CM

código	dimensões	preço
PP04CR	4,4x5x5cm	

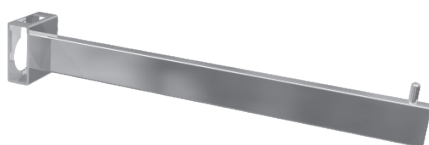

RT RETO

código	dimensões	preço
PP06CR10	4,4x5x10cm	
PP06CR30	4,4x5x30cm	
tubo 10x30		

ACABAMENTOS

CR (cromado)

PREÇOS COM IPI

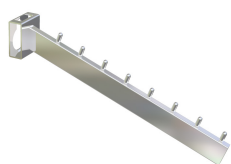

RT INCLINADO

código	dimensões	preço
PP07CR30	4,4x14x30cm	
tubo 10x30		



MÃO FRANCESA

código	dimensões	preço
PP08CR30	4,4x5x30cm	
PP08CR35	4,4x5x35cm	
tubo 10x30		



GANCHO SEM ESFERA

código	dimensões	preço
PP13CR10	4,4x5x10cm	
PP13CR15	4,4x5x15cm	
PP13CR20	4,4x5x20cm	
arame Ø 6mm		



GANCHO BARRA 10X30

código	dimensões	preço
PP15CR10	3,5x3,7x10cm	
PP15CR15	3,5x3,7x15cm	
PP15CR20	3,5x3,7x20cm	
arame Ø 6mm		



PORTA BONÉ

código	dimensões	preço
PP11CR	12x14x27cm	
arame Ø 3mm		



PORTA BOLA

código	dimensões	preço
PP12CR	5x15x26cm	
arame Ø 6mm		

ACABAMENTOS

CR (cromado)

PREÇOS COM IPI





CREMALHEIRA ALUMÍNIO ESQUERDA 18

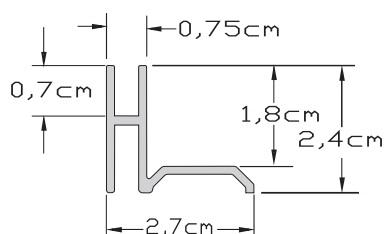

código	dimensões	preço
--------	-----------	-------

9511AND	2,4x2,7x255cm	
---------	---------------	--

somente anodizado fosco
obs: usar MDF de 18

CREMALHEIRA ALUMÍNIO SIMPLES 18

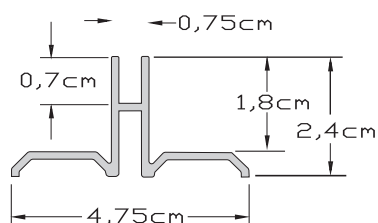

código	dimensões	preço
--------	-----------	-------

9505AND	2,4x4,75x255cm	
---------	----------------	--

somente anodizado fosco
obs: usar MDF de 18

CREMALHEIRA ALUMÍNIO DUPLA 18

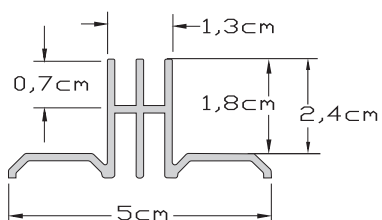

código	dimensões	preço
--------	-----------	-------

9500AND	2,4x5x255cm	
---------	-------------	--

somente anodizado fosco
obs: usar MDF de 18

ACABAMENTOS

CR (cromado)

PREÇOS COM IPI

CREMALHEIRA ALUMÍNIO DIREITA 18

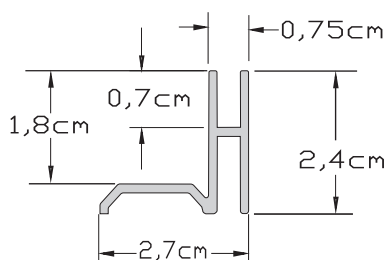

código	dimensões	preço
--------	-----------	-------

9510AND	2,4x2,7x255cm	
---------	---------------	--

somente anodizado fosco

obs: usar MDF de 18

CREMALHEIRA ALUMÍNIO ESQUERDA 15

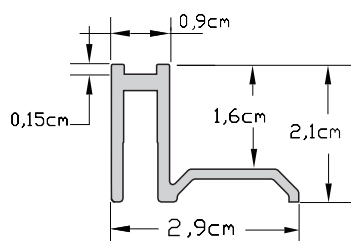

código	dimensões	preço
--------	-----------	-------

9514AND	2,1x2,9x255cm	
---------	---------------	--

anodizado fosco

obs: usar MDF de 15

CREMALHEIRA ALUMÍNIO SIMPLES 15

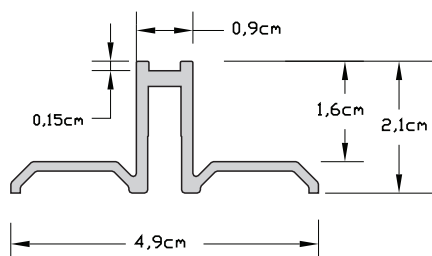

código	dimensões	preço
--------	-----------	-------

9512AND	2,1x4,9x255cm	
---------	---------------	--

anodizado fosco

obs: usar MDF de 15

CREMALHEIRA ALUMÍNIO DUPLA 15

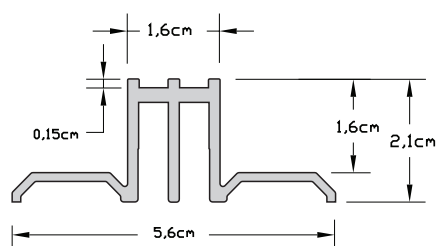

código	dimensões	preço
--------	-----------	-------

9513AND	2,1x5,6x255cm	
---------	---------------	--

anodizado fosco

obs: usar MDF de 15

ACABAMENTOS

CR (cromado)

PREÇOS COM IPI

CREMALHEIRA ALUMÍNIO DIREITA 15

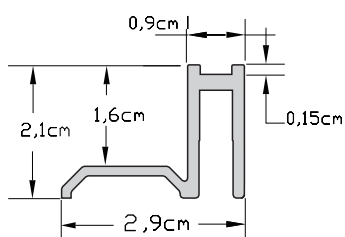

código	dimensões	preço
--------	-----------	-------

9516 AND	2,1x2,9x255cm	
-----------------	---------------	--

anodizado fosco

obs: usar MDF de 15

CREMALHEIRA SIMPLES 1,8CM

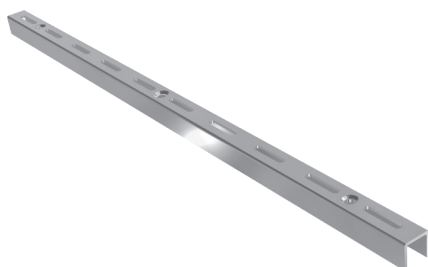

código	dimensões	preço
--------	-----------	-------

6120_ _*	1,8x1,9x122cm	
----------	---------------	--

6120 CR	1,8x1,9x122cm	
----------------	---------------	--

6125_ _*	1,8x1,9x198cm	
----------	---------------	--

6125 CR	1,8x1,9x198cm	
----------------	---------------	--

pintado, cromado

obs: passo 50mm

CREMALHEIRA DUPLA 1,8CM

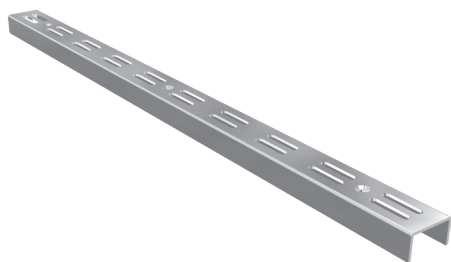

código	dimensões	preço
--------	-----------	-------

6130_ _*	1,8x3,2x122cm	
----------	---------------	--

6130 CR	1,8x3,2x122cm	
----------------	---------------	--

6135_ _*	1,8x3,2x198cm	
----------	---------------	--

6135 CR	1,8x3,2x198cm	
----------------	---------------	--

pintado, cromado

obs: passo 50mm

MÃO FRANCESA 35CM CREMALHEIRA 15X35



código	dimensões	preço
--------	-----------	-------

A-01 CR 35	1,5x7,5x35cm	
-------------------	--------------	--

tubo 15x35

ACABAMENTOS

CR (cromado)

PREÇOS COM IPI

SUP. INVISIVEL 35CM CREMALHEIRA



código	dimensões	preço
A-02CR35	1,6x7,5x35cm	

tubo 16x16

RT RETO 35CM CREMALHEIRA 15X35



código	dimensões	preço
A-03CR35	1,5x7,5x35cm	

8590CR 1,5x7,5x35cm
*versão com parafuso de trava

tubo 15x35

SUP. ARARA 35CM CREMALHEIRA 15X35



código	dimensões	preço
A-04CR35	4x7,5x35cm	

tubo 15x35

TRAVESSA ARARA 15X35

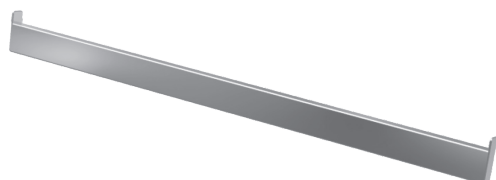

código	dimensões	preço
A-05CR80	1,5x3,5x80cm	
A-05CR100	1,5x3,5x100cm	
A-05CR120	1,5x3,5x120cm	

tubo 15x35

ACABAMENTOS

CR (cromado)

PREÇOS COM IPI

SUP. P/ BARRA 5CM CREMALHEIRA 15X35



código	dimensões	preço
A-06CR05	1,5x7,5x8,5cm	

BARRA FIXA 15X35 CREMALHEIRA



código	dimensões	preço
8675__	5x7x80cm	
A-08CR80	5x7x80cm	
8680__	5x7x100cm	
A-08CR100	5x7x100cm	
8685__	5x7x120cm	
A-08CR120	5x7x120cm	

Não compatível com cremalheiras de alumínio para MDF de 18mm: 9511AND, 9505AND, 9500AND E 9510AND.

tubo 15x35
OBS: BARRA FIXA PINTADA COM ENGATE SOLDADO.

ARARA FIXA 15X35 CREMALHEIRA



código	dimensões	preço
A-16__*80	5x7x80cm	
A-16CR80	5x7x80cm	
A-16__*100	5x7x100cm	
A-16CR100	5x7x100cm	
A-16__*120	5x7x120cm	
A-16CR120	5x7x120cm	

Não compatível com cremalheiras de alumínio para MDF de 18mm: 9511AND, 9505AND, 9500AND E 9510AND.

tubo 15x35

ACABAMENTOS

CR (cromado)

PREÇOS COM IPI

MÃO FRANCESA 35CM BARRA 15X35



código	dimensões	preço
--------	-----------	-------

A-09CR35	4x5x35cm	
----------	----------	--

tubo 15x35

RT RETO 35CM BARRA 15X35



código	dimensões	preço
--------	-----------	-------

A-10CR35	4x5x35cm	
----------	----------	--

tubo 15x35

PORTA CALÇADO BARRA 15X35

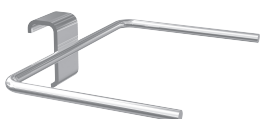

código	dimensões	preço
--------	-----------	-------

A-11CR	4x10x15cm	
--------	-----------	--

arame ø 6mm

GANCHO SEM ESFERA BARRA 15X35



código	dimensões	preço
--------	-----------	-------

A-15CR15	4x5x15cm	
----------	----------	--

A-15CR20	4x5x20cm	
----------	----------	--

A-15CR25	4x5x25cm	
----------	----------	--

arame ø 6mm

ACABAMENTOS

CR (cromado)

PREÇOS COM IPI

MÃO FRANCESA C/ ABA CREM.

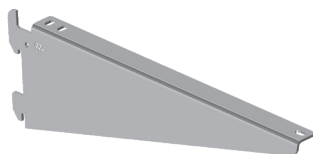

código	dimensões	preço
6055__*	2x9,6x25cm	
6055CR	2x9,6x25cm	
6060__*	2x9,6x30cm	
6060CR	2x9,6x30cm	
6065__*	2x9,6x35cm	
6065CR	2x9,6x35cm	
6070__*	2x9,6x40cm	
6070CR	2x9,6x40cm	

pintado, cromado

ARARA FIXA CREMALHEIRA



código	dimensões	preço
6185__*	9,5x30x100cm	
6185CR	9,5x30x100cm	
6190__*	9,5x30x120cm	
6190CR	9,5x30x120cm	

tubo 16x30

pintado, cromado

Não compatível com cremalheiras de alumínio para MDF de 18mm:
9511AND, 9505AND, 9500AND E 9510AND.

ACABAMENTOS

CR (cromado)

PREÇOS COM IPI

TRAV. FIXA CREM.



código	dimensões	preço
6205__*	6x9,5x100cm	
6205CR	6x9,5x100cm	
6210__*	6x9,5x120cm	
6210CR	6x9,5x120cm	

tubo 16x30

Não compatível com cremalheiras de alumínio para MDF de 18mm:
9511AND, 9505AND, 9500AND E 9510AND.

SUPORE P/ TRAV. TB. OBL. CREM.

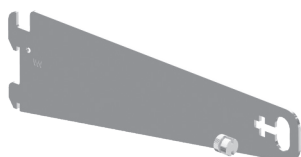

código	dimensões	preço
6440__*	2,6x9,5x32cm	
6440CR	2,6x9,5x32cm	

SUPORE P/ TRAV. TB. OBL. CREM.



código	dimensões	preço
6445__*	2,6x8x9,5cm	
6445CR	2,6x8x9,5cm	

TRAV. TUBO OBLONGO

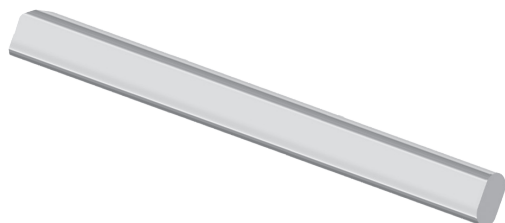

código	dimensões	preço
2075CR	1,6x3x65cm	
2080CR	1,6x3x85cm	
2085CR	1,6x3x105cm	
2090CR	1,6x3x125cm	

cromado

ACABAMENTOS

CR (cromado)

*Pintura:
B (branco azulado)
P (preto semi fosco)
PTA (prata)

PREÇOS COM IPI

RT INCL. BARRA OBL.

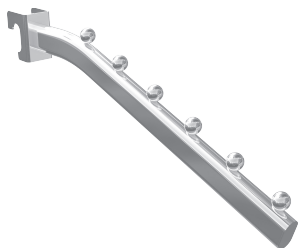

código	dimensões	preço
--------	-----------	-------

4035__*	3,5x14x35cm	
---------	-------------	--

4035CR	3,5x14x35cm	
--------	-------------	--

pintado, cromado

tubo 16x30

RT RETO BARRA OBL.

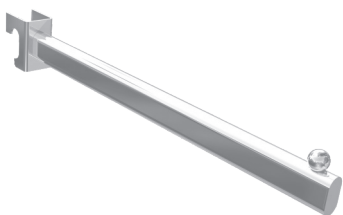

código	dimensões	preço
--------	-----------	-------

4045__*	3,5x4,5x35cm	
---------	--------------	--

4045CR	3,5x4,5x35cm	
--------	--------------	--

pintado, cromado

tubo 16x30

CABIDE PROVADOR PREMIUM 30



código	dimensões	preço
--------	-----------	-------

8235CR	3x3x6cm	
--------	---------	--

cromado

tubo Ø 1.1/4 pol

PORTA BONÉ BARRA 15X35



código	dimensões	preço
--------	-----------	-------

A-12CR	12x12x25cm	
--------	------------	--

arame Ø 3mm

PORTA BOLA BARRA 15X35



código	dimensões	preço
--------	-----------	-------

A-13CR	5x15x24cm	
--------	-----------	--

arame Ø 6mm

ACABAMENTOS

CR (cromado)

PREÇOS COM IPI



WAVE PAREDE C



código	dimensões	preço
--------	-----------	-------

WC__*60	66,5X38,3x232cm	
---------	-----------------	--

WC__*120	126,5X38,3x232cm	
----------	------------------	--

tubo ø 28.6mm

WAVE PAREDE CT

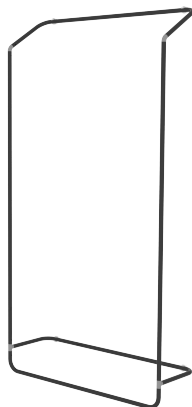

código	dimensões	preço
--------	-----------	-------

WCT__*60	66,5X38,3x232cm	
----------	-----------------	--

WCT__*120	126,5X38,3x232cm	
-----------	------------------	--

tubo ø 28.6mm

WAVE PAREDE CY

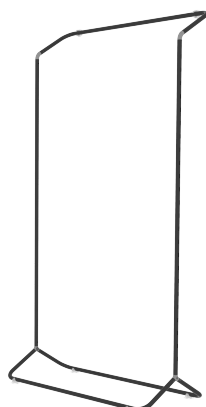

código	dimensões	preço
--------	-----------	-------

WCY__*60	66,5X38,3x232cm	
----------	-----------------	--

WCY__*120	126,5X38,3x232cm	
-----------	------------------	--

tubo ø 28.6mm

ACABAMENTOS

BF (branco fosco)
BT (branco total)
PT (prata)

PR (preto semi fosco)
PX (preto micro texturizado)

WAVE PAREDE YY

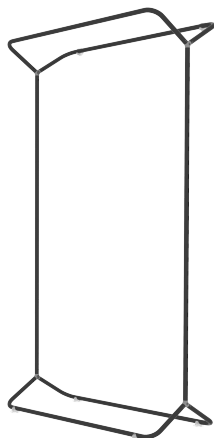

código	dimensões	preço
--------	-----------	-------

WYY__*60	66,5X38,3x232cm	
----------	-----------------	--

WYY__*120	126,5X38,3x232cm	
-----------	------------------	--

tubo ø 28.6mm

WAVE PAREDE T

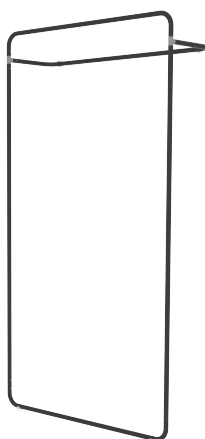

código	dimensões	preço
--------	-----------	-------

WT__*60	66,5X38,3x232cm	
---------	-----------------	--

WT__*120	126,5X38,3x232cm	
----------	------------------	--

tubo ø 28.6mm

WAVE PAREDE TT

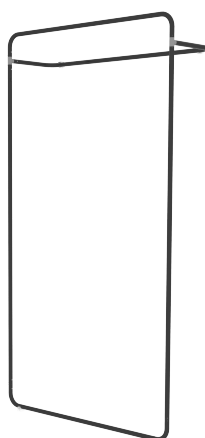

código	dimensões	preço
--------	-----------	-------

WTT__*60	66,5X38,3x232cm	
----------	-----------------	--

WTT__*120	126,4X38,3x232cm	
-----------	------------------	--

tubo ø 28.6mm

ACABAMENTOS

BF (branco fosco)
BT (branco total)
PT (prata)

PR (preto semi fosco)
PX (preto micro texturizado)

WAVE PISO Y TORRE

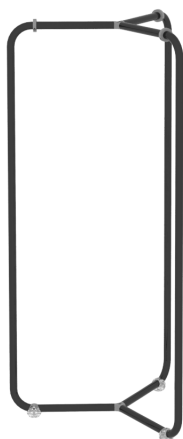

código	dimensões	preço
WPYT__*	60X60x145cm	

tubo ø 28.6mm

WAVE PISO TT



código	dimensões	preço
WP__*	62,8X62,8x244cm	

tubo ø 28.6mm

WAVE PISO Y

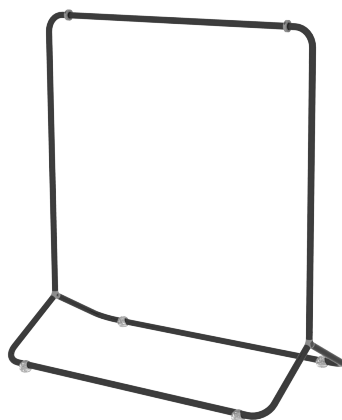

código	dimensões	preço
WPY__*	130X70x146cm	

tubo ø 28.6mm

ACABAMENTOS

BF (branco fosco)
BT (branco total)
PT (prata)

PR (preto semi fosco)
PX (preto micro texturizado)

WAVE PISO 2Y

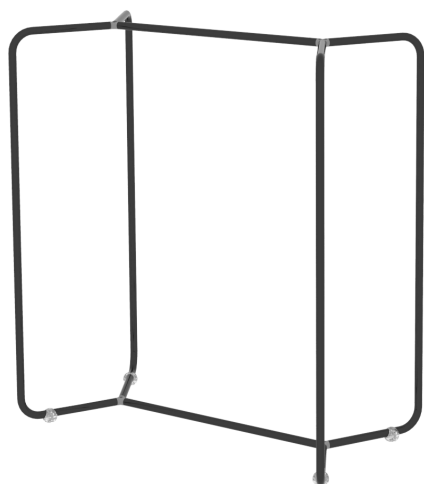

código	dimensões	preço
WP2Y__*	130X70x145cm	

tubo ø 28.6mm

WAVE PISO 0

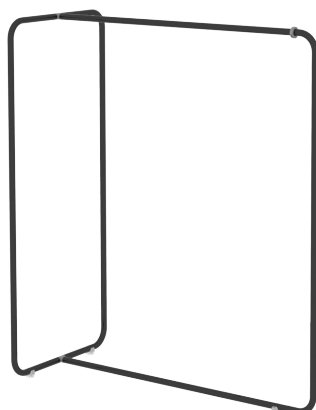

código	dimensões	preço
WPO__*	137X70x146cm	

tubo ø 28.6mm

WAVE PISO X

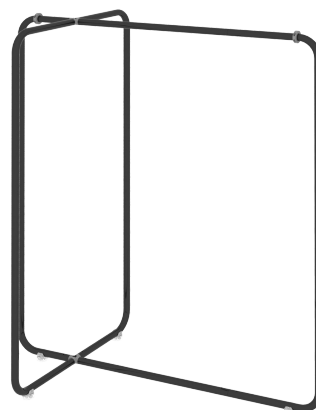

código	dimensões	preço
WPX__*	130X77x145cm	

tubo ø 28.6mm

ACABAMENTOS

BF (branco fosco)
BT (branco total)
PT (prata)

PR (preto semi fosco)
PX (preto micro texturizado)

WAVE PISO CURVA G

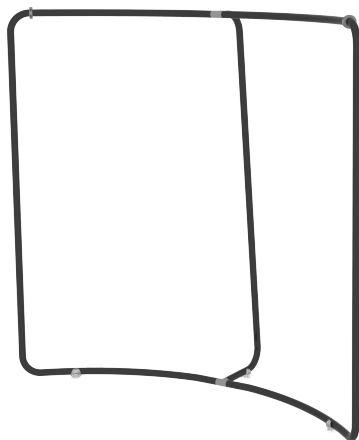

código	dimensões	preço
--------	-----------	-------

WPC__*P	156X60x145cm	
---------	--------------	--

WPC__*G	156X60x114cm	
---------	--------------	--

tubo ø 28.6mm

WAVE MESA C



código	dimensões	preço
--------	-----------	-------

WMC__*P	90X60x41cm	
---------	------------	--

WMC__*M	100X60x60cm	
---------	-------------	--

WMC__*G	130X60x80cm	
---------	-------------	--

tubo ø 28.6mm

WAVE MESA Y



código	dimensões	preço
--------	-----------	-------

WMY__*P	90X70x41cm	
---------	------------	--

WMY__*M	120X70x60cm	
---------	-------------	--

WMY__*G	160X70x80cm	
---------	-------------	--

tubo ø 28.6mm

ACABAMENTOS

BF (branco fosco)
BT (branco total)
PT (prata)

PR (preto semi fosco)
PX (preto micro texturizado)

WAVE MESA X



código	dimensões	preço
WMX__*P	100X50x41cm	
WMX__*M	125X65x60cm	
WMX__*G	140X80x80cm	

tubo ø 28.6mm

WAVE PRECIFICADOR LATERAL



código	dimensões	preço
WAVE02AND	1,6X7x8cm	

Para tubo ø 28.6mm

WAVE PRECIFICADOR FRONTAL



código	dimensões	preço
WAVE01AND	3X6,8x8cm	

DEMAIS ACESSÓRIOS DISPONÍVEIS DA PÁG 56 Á 59 (LINHA SIDE)

Exceto Régua Recuada (SIDE52 e SIDE53)

ACABAMENTOS

BF (branco fosco)
BT (branco total)
PT (prata)

PR (preto semi fosco)
PX (preto micro texturizado)



SIDE PAREDE 60CM

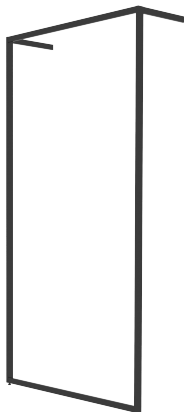

código	dimensões	preço
SIDE15	65,5x45x200cm	
SIDE16	65,5x45x220cm	
SIDE17	65,5x45x240cm	

tubo 20x40

SIDE PAREDE 120CM

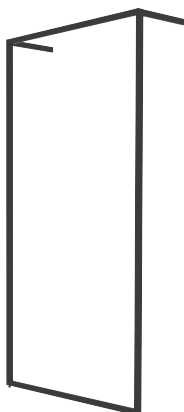

código	dimensões	preço
SIDE18	125,5x45x200cm	
SIDE19	125,5x45x220cm	
SIDE20	125,5x45x240cm	

tubo 20x40

SIDE PISO 60CM

Profundidade 49cm



código	dimensões	preço
SIDE21	65,5x49x90cm	
SIDE22	65,5x49x120cm	
SIDE23	65,5x49x140cm	
SIDE24	65,5x49x160cm	
SIDE25	65,5x49x200cm	
SIDE26	65,5x49x220cm	
SIDE27	65,5x49x240cm	

tubo 20x40

ACABAMENTOS

*Pintura:

BF (branco fosco)

BT (branco total)

PT (prata)

PR (preto semi fosco)

PX (preto micro texturizado)

PREÇOS COM IPI

SIDE PISO 60CM

Profundidade 69,5cm

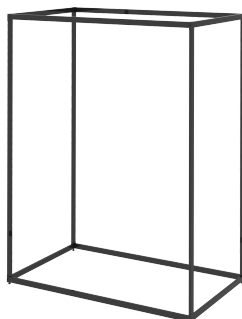

código	dimensões	preço
SIDE28	65,5x69,5x90cm	
SIDE29	65,5x69,5x120cm	
SIDE30	65,5x69,5x140cm	
SIDE31	65,5x69,5x160cm	
SIDE32	65,5x69,5x200cm	
SIDE33	65,5x69,5x220cm	
SIDE34	65,5x69,5x240cm	

tubo 20x40

SIDE PISO 120CM

Profundidade 49cm



código	dimensões	preço
SIDE35	125,5x49x90cm	
SIDE36	125,5x49x120cm	
SIDE37	125,5x49x140cm	
SIDE38	125,5x49x160cm	
SIDE39	125,5x49x200cm	
SIDE40	125,5x49x220cm	
SIDE41	125,5x49x240cm	

tubo 20x40

SIDE PISO 120CM

Profundidade 69,5cm

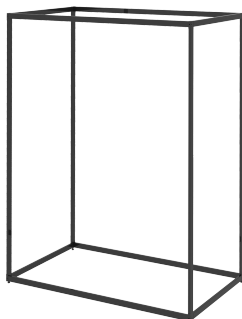

código	dimensões	preço
SIDE42	125,5x69,5x90cm	
SIDE43	125,5x69,5x120cm	
SIDE44	125,5x69,5x140cm	
SIDE45	125,5x69,5x160cm	
SIDE46	125,5x69,5x200cm	
SIDE47	125,5x69,5x220cm	
SIDE48	125,5x69,5x240cm	

tubo 20x40

ACABAMENTOS

*Pintura:

BF (branco fosco)

BT (branco total)

PT (prata)

PR (preto semi fosco)

PX (preto micro texturizado)

PREÇOS COM IPI



SIDE MESA

	código	dimensões	preço
PP	SIDE83	110x49x40cm	
P	SIDE50	110x49x70cm	
M	SIDE84	125,5x69,5x70cm	
G	SIDE51	125,5x69,5x90cm	

**Tampo mesa PP e P 110x49cm | Tampo mesa M e G 125,5x69,5cm
não acompanha madeira
tubo 20x40

RÉGUA RECUADA

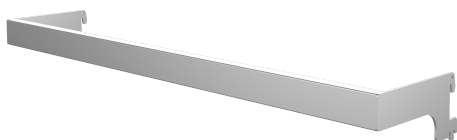

	código	dimensões	preço
	SIDE52	63,5cm	
	SIDE53	123,5cm	

tubo 15x35

RÉGUA RETA



	código	dimensões	preço
	SIDE54	63,5cm	
	SIDE55	123,5cm	

tubo 15x35

ACABAMENTOS

*Pintura:

BF (branco fosco)

BT (branco total)

PT (prata)

PR (preto semi fosco)

PX (preto micro texturizado)

PREÇOS COM IPI

**Sugestão de tamanho mínimo.

MÃO FRANCESA

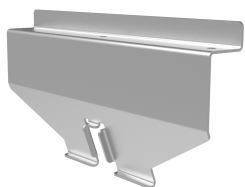

código	dimensões	preço
SIDE56	3x20x8,3cm	
	20cm	Valor unitário

Recomendável utilizar somente com madeira

BANDEJA BAIXA



código	dimensões	preço
SIDE57	60x38x4,4cm	

BANDEJA ALTA



código	dimensões	preço
SIDE58	60x38x8,3cm	

RT RETO



código	dimensões	preço
SIDE59	15x35x20cm	
SIDE70	15x35x30cm	
		tubo 15x35

RT DUPLO

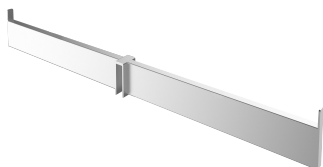

código	dimensões	preço
SIDE60	15x35x38cm	
		tubo 15x35

ACABAMENTOS

*Pintura:

BF (branco fosco)

BT (branco total)

PT (prata)

PR (preto semi fosco)

PX (preto micro texturizado)

PREÇOS COM IPI

GANCHO PARA BARRA



código	dimensões	preço
SIDE61	15cm	
SIDE62	20cm	
SIDE63	25cm	

Gancho para barra 15x35

GANCHO PARA PAINEL



código	dimensões	preço
SIDE64	15cm	
SIDE65	20cm	
SIDE66	25cm	

Gancho para painel de acessórios

PRECIFICADOR PRATELEIRA



código	dimensões	preço
SIDE71	20x1,8x8cm	

PAINEL DE ACESSÓRIOS



código	dimensões	preço
SIDE72	59x6,7x98cm	

ACABAMENTOS

*Pintura:

BF (branco fosco)

BT (branco total)

PT (prata)

PR (preto semi fosco)

PX (preto micro texturizado)

PREÇOS COM IPI



ESPELHO

código	dimensões	preço
SIDE73	50x6,7x160cm	
SIDE74	50x6,7x240cm	

acompanha espelho

ACABAMENTOS

*Pintura:

BF (branco fosco)

BT (branco total)

PT (prata)

PR (preto semi fosco)

PX (preto micro texturizado)

PREÇOS COM IPI



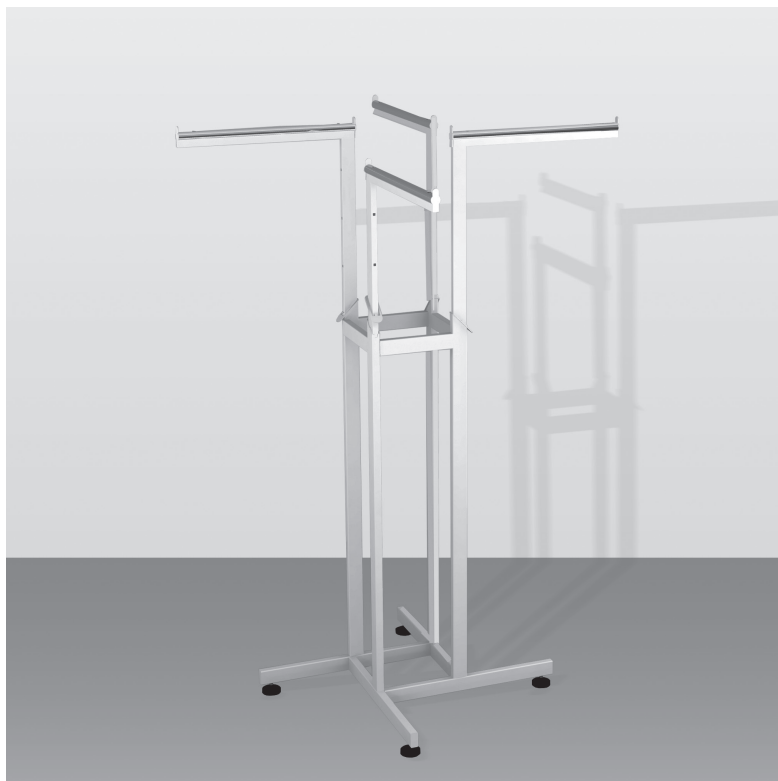

ARARA 4 BRAÇOS

código	dimensões	preço
RBT01__*	112x112x114cm mín 112x112x165cm máx	

pintado
tubo 20x40

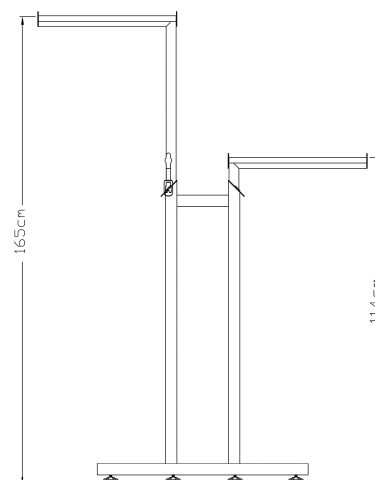

ARARA 4 BRAÇOS PARALELA

código	dimensões	preço
RBT02__*	60x62x114cm mín 60x62x165cm máx	

pintado
tubo 20x40

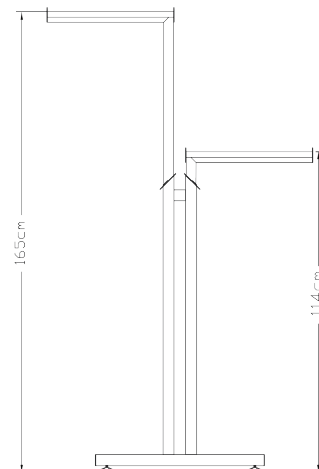

ACABAMENTOS

*Pintura:

BF (branco fosco)

BT (branco total)

PT (prata)

PR (preto semi fosco)

PX (preto micro texturizado)

PREÇOS COM IPI



ARARA 2 BRAÇOS CONJUGADA

código	dimensões	preço
RBT03__*	60x62x114cm mín 60x62x165cm máx	

tubo 20x40

prateleira não inclusa

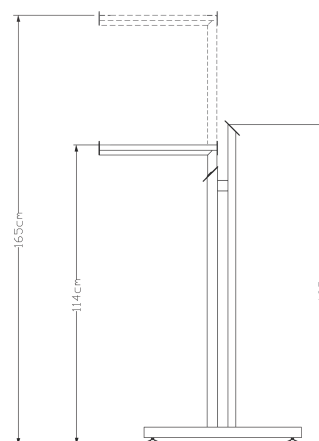

MÃO FRANCESA

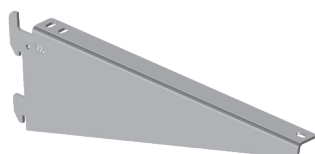

código	dimensões	preço
6055__*	2x9,5x25cm	
6055CR	2x9,5x25cm	
6060__*	2x9,5x30cm	
6060CR	2x9,5x30cm	
6065__*	2x9,5x35cm	
6065CR	2x9,5x35cm	
6070__*	2x9,5x40cm	
6070CR	2x9,5x40cm	

pintado e cromado

ACABAMENTOS

*Pintura:

BF (branco fosco)

BT (branco total)

PT (prata)

PR (preto semi fosco)

PX (preto micro texturizado)

PREÇOS COM IPI



GÔNDOLA

código	dimensões	preço
RBT04_ _ *	59x120x143cm	

tubo 30x30

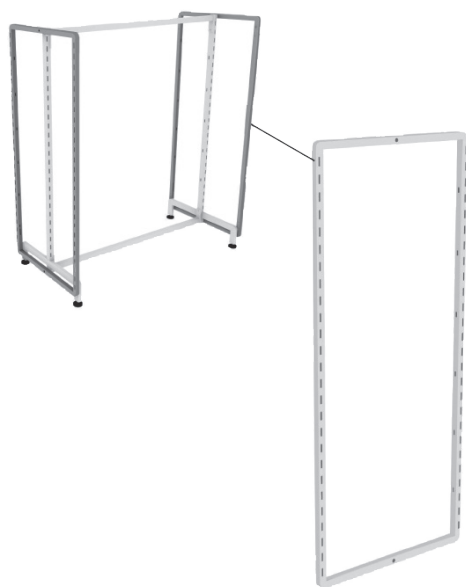

CABECEIRA

código	dimensões	preço
RBT05_ _ *	2,5x61,6x136,6cm	

tubo 25x25

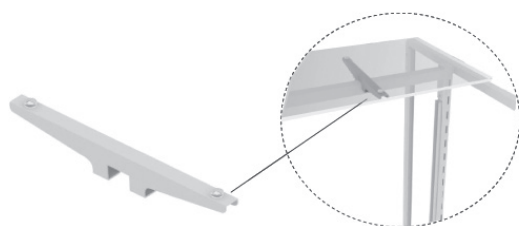

MÃO FRANCESA

código	dimensões	preço
RBT08_ _ *	2x4x30cm	

ACABAMENTOS

*Pintura:

BF (branco fosco)

BT (branco total)

PT (prata)

PR (preto semi fosco)

PX (preto micro texturizado)

PREÇOS COM IPI



ARARA DESFILE SIMPLES DOBRÁVEL

código	dimensões	preço
7000CR	55x127x140 mín 55x163x167 máx	

cromado

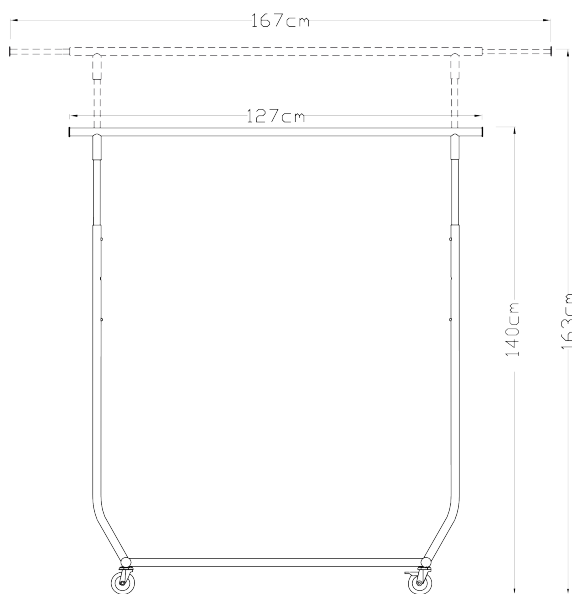

ARARA DESFILE DUPLA DOBRÁVEL

código	dimensões	preço
7005CR	55x127x140 mín 55x163x167 máx	

cromado

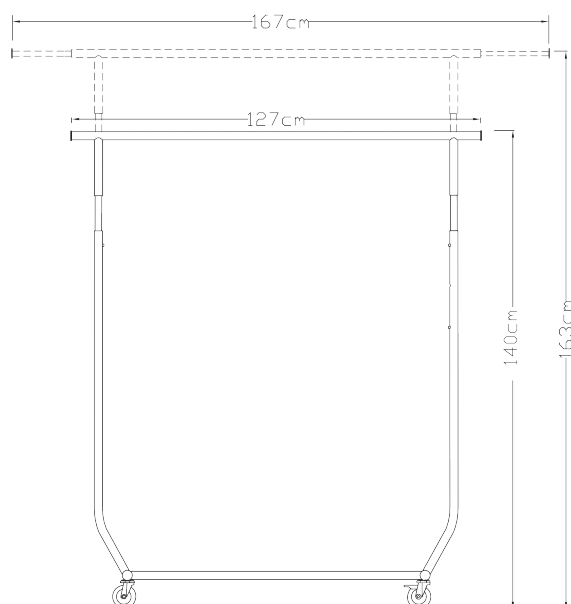



ARARA DESFILE SIMPLES MILL

código	dimensões	preço
7400CR	48x118x118 mín 48x157x170 máx	

cromado

tubo 25x25

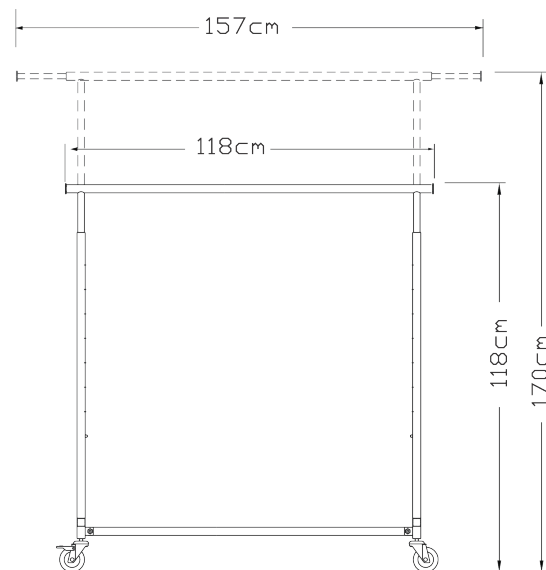

ARARA DESFILE DUPLA P30

código	dimensões	preço
8411CR	50x120x125cm mín 50x120x190cm máx	

cromado

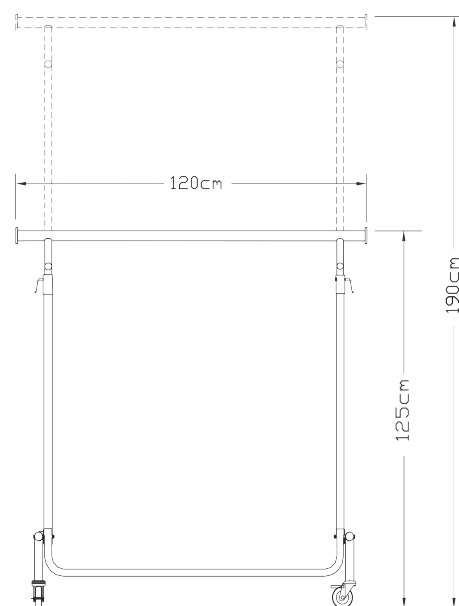

Imagens meramente ilustrativas.

Medidas apenas nominais, sujeitas a alterações sem aviso prévio. Para medidas técnicas, consultar.

A Wiring se reserva o direito de fazer alterações sem prévio aviso.

Desenvolvemos projetos especiais com diversas seleções de tubos de acordo com a necessidade do cliente.

